

# Push-pull Connectors

Part No: 0BRGGD05CLAD52Z



[www.rlcables.com](http://www.rlcables.com)

0B Series 5-Cores , Straight plug , Sheath type



## Technical parameter

Mechanical Properties	
Shell style	Straight plug
Sheating material	Brass shell and collet nut , nickel plated. Brass latch sleeve and mid pieces
Colour	Grey
Locking method	Push-pull
Plug-and-play count	>5000 times
Temperature range	-55° C / +250° C
Water resistance level	IP50
Adapter cable	4.30 - 5.20mm

Electric properties	
Internal components	5 Pins
Conductor Structure	Brass gold plated
Insulation	Peek
Conductor diameter	0.7 mm
Salt spray test	>144Hr
Maximum contact resistance	6.1 mOhm
Rated current	5 A
Test voltage ( Contact - Shell )	1 KV(DC)

# Push-pull Connectors

Part No: 0BRGGD05CLAD52Z



[www.rlcables.com](http://www.rlcables.com)

Drawing

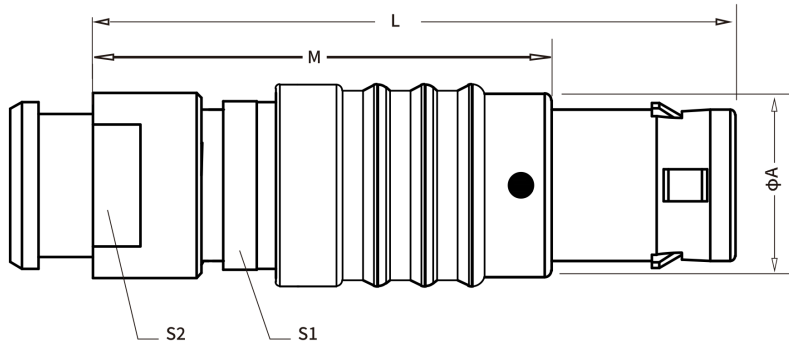

Insert Configuration  
Rear View

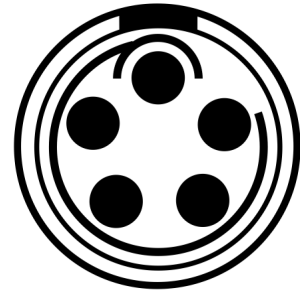

Size (mm)				
A	L	M	S1	S2
9.5	35.0	25.0	8.0	7.0