

Push-pull Connectors

Part No: 0BRGGD06CLAD52Z



www.rlcables.com

0B Series 6-Cores , Straight plug , Sheath type



Technical parameter

Mechanical Properties	
Shell style	Straight plug
Sheating material	Brass shell and collet nut , nickel plated. Brass latch sleeve and mid pieces
Colour	Grey
Locking method	Push-pull
Plug-and-play count	>5000 times
Temperature range	-55° C / +250° C
Water resistance level	IP50
Adapter cable	4.30 - 5.20mm

Electric properties	
Internal components	6 Pins
Conductor Structure	Brass gold plated
Insulation	Peek
Conductor diameter	0.5 mm
Salt spray test	>144Hr
Maximum contact resistance	8.7 mOhm
Rated current	3 A
Test voltage (Contact - Shell)	0.9 KV(DC)

Push-pull Connectors

Part No: 0BRGGD06CLAD52Z



www.rlcables.com

Drawing

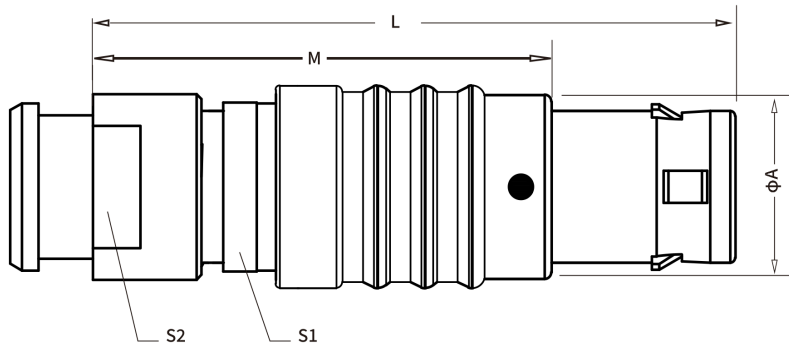

Insert Configuration
Rear View

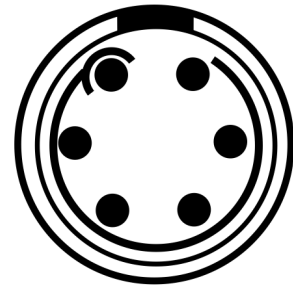

Size (mm)				
A	L	M	S1	S2
9.5	35.0	25.0	8.0	7.0