

Push-pull Connectors

Part No: 1BRGGD03CLAD42



www.rlcables.com

1B Series 3-Cores , Straight plug



Technical parameter :

Mechanical Properties	
Shell style	Straight plug
Sheating material	Brass shell and collet nut , nickel plated. Brass latch sleeve and mid pieces
Colour	Grey
Locking method	Push-pull
Plug-and-play count	>5000 times
Temperature range	-55° C / +250° C
Water resistance level	IP50
Adapter cable	3.10 - 4.20mm

Electric properties	
Internal components	3 Pins
Conductor Structure	Brass gold plated
Insulation	Peek
Conductor diameter	1.3mm
Salt spray test	>144Hr
Maximum contact resistance	3.6 mOhm
Rated current	12A
Test voltage (Contact - Shell)	2.2KV (DC)

Push-pull Connectors

Part No: 1BRGGD03CLAD42



www.rlcables.com

Drawing

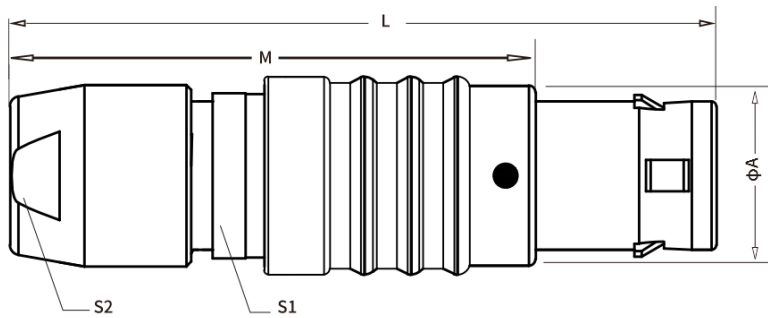

Insert Configuration
Rear View



Size (mm)				
A	L	M	S1	S2
12.0	43.0	32.0	10.0	9.0