

Push-pull Connectors

Part No: 1BRGGD16CLAD62



www.rlcables.com

1B Series 16-Cores , Straight plug



Technical parameter :

Mechanical Properties	
Shell style	Straight plug
Sheating material	Brass shell and collet nut , nickel plated. Brass latch sleeve and mid pieces
Colour	Grey
Locking method	Push-pull
Plug-and-play count	>5000 times
Temperature range	-55° C / +250° C
Water resistance level	IP50
Adapter cable	5.30 - 6.20mm

Electric properties	
Internal components	16 Pins
Conductor Structure	Brass gold plated
Insulation	Peek
Conductor diameter	0.5mm
Salt spray test	>144Hr
Maximum contact resistance	8.7 mOhm
Rated current	2A
Test voltage (Contact - Shell)	1.8KV (DC)

Push-pull Connectors

Part No: 1BRGGD16CLAD62



www.rlcables.com

Drawing

Insert Configuration
Rear View

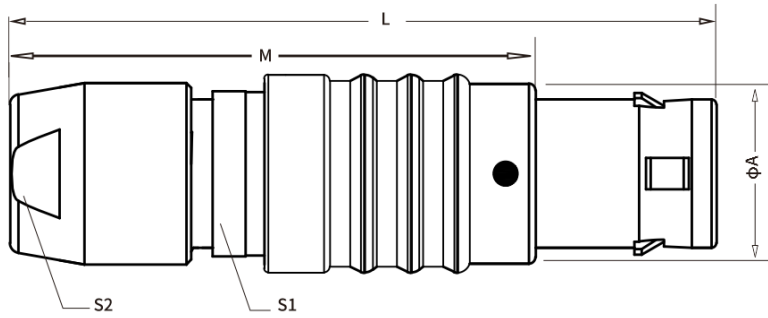

Size (mm)				
A	L	M	S1	S2
12.0	43.0	32.0	10.0	9.0