

Push-pull Connectors

Part No: 0TRGGD03CLAC40



www.rlcables.com

0T Series 3-Cores , Straight plug



Technical parameter :

Mechanical Properties	
Shell style	Straight plug
Sheating material	Brass shell and collet nut , nickel plated. Brass latch sleeve and mid pieces
Colour	Grey
Locking method	Push-pull
Plug-and-play count	>3000 times
Temperature range	-55° C / +200° C
Water resistance level	IP68
Adapter cable	3.60-4.00mm

Electric properties	
Internal components	3 Pins
Conductor Structure	Brass gold plated
Insulation	Peek
Conductor diameter	0.9mm
Salt spray test	>144Hr
Maximum contact resistance	4.8 mOhm
Rated current	8A
Test voltage (Contact - Shell)	1.3KV (DC)

Push-pull Connectors

Part No: 0TRGGD03CLAC40



www.rlcables.com

Drawing

Insert Configuration
Rear View

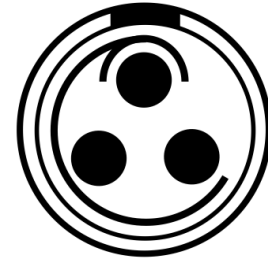
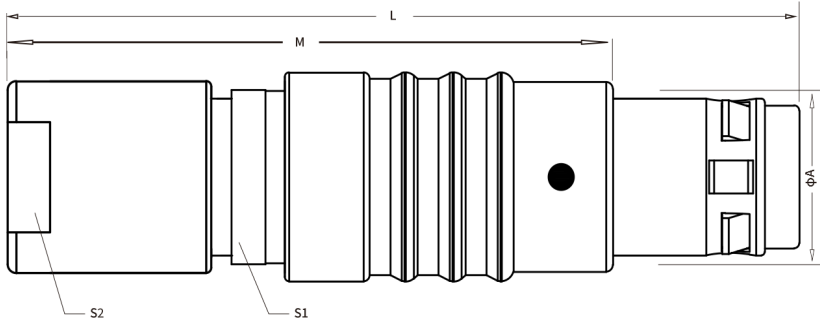

Size (mm)				
A	L	M	S1	S2
9.5	39.0	29.0	7.5	7.0