

Push-pull Connectors

Part No: 2BRGGD14CLAD62



www.rlcables.com

2B Series 14-Cores , Straight plug



Technical parameter :

Mechanical Properties	
Shell style	Straight plug
Sheating material	Brass shell and collet nut , nickel plated. Brass latch sleeve and mid pieces
Colour	Grey
Locking method	Push-pull
Plug-and-play count	>5000 times
Temperature range	-55°C / +250°C
Water resistance level	IP50
Adapter cable	5.30-6.20mm

Electric properties	
Internal components	14 Pins
Conductor Structure	Brass gold plated
insulation	Peek
Conductor diameter	0.9mm
Salt spray test	>144Hr
Maximum contact resistance	4.8 mOhm
Rated current	8 A
Test voltage (Contact - Shell)	1.9KV (DC)

Push-pull Connectors

Part No: 2BRGGD14CLAD62



www.rlcables.com

Drawing:

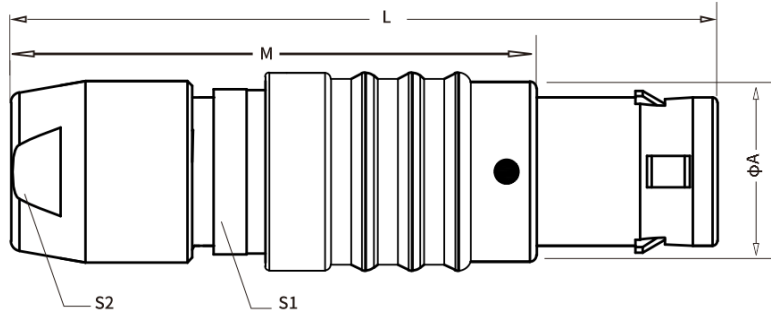

Insert Configuration
Rear View



Size (mm)				
A	L	M	S1	S2
15.0	50.0	38.0	13.0	12.0