

Push-pull Connectors

Part No: 1TRGGD06CLAC50Z



www.rlcables.com

1T Series 6-Cores , Straight plug , Sheath type



Technical parameter

Mechanical Properties	
Shell style	Straight plug
Sheating material	Brass shell and collet nut , nickel plated. Brass latch sleeve and mid pieces
Colour	Grey
Locking method	Push-pull
Plug-and-play count	>3000 times
Temperature range	-55° C / +200° C
Water resistance level	IP68
Adapter cable	4.60-5.00mm

Electric properties	
Internal components	6 Pins
Conductor Structure	Brass gold plated
Insulation	Peek
Conductor diameter	0.7 mm
Salt spray test	>144Hr
Maximum contact resistance	6.1 mOhm
Rated current	7 A
Test voltage (Contact - Shell)	1.7 KV(DC)

Push-pull Connectors

Part No: 1TRGGD06CLAC50Z



www.rlcables.com

Drawing

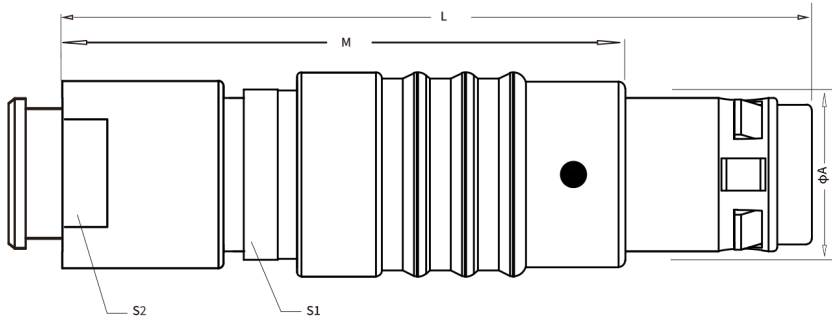

Insert Configuration
Rear View

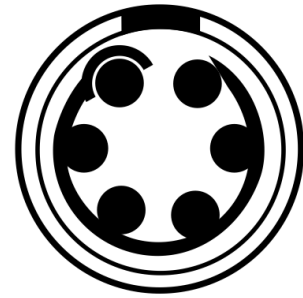

Size (mm)				
A	L	M	S1	S2
12.0	45.0	34.0	11.0	9.0